

## Half Bridge IGBT Module

### 电气特性:

- 1200V 沟槽栅/场终止工艺
- 低开关损耗
- 正温度系数

### 典型应用:

- 变频器
- UPS
- 伺服
- 逆变器

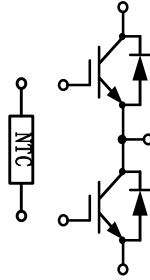

$V_{CES} = 1200V$ ,  $I_{C\ nom} = 450A$  /  $I_{CRM} = 900A$

## IGBT, 逆变器 / IGBT, Inverter

### 最大额定值 / Maximum Ratings

Parameter	Conditions	Symbol	Value	Unit
集电极-发射极电压 Collector-Emitter voltage	$T_{vj} = 25^{\circ}C$	$V_{CES}$	1200	V
连续集电极直流电流 Continuous DC collector current	$T_C = 100^{\circ}C$ , $T_{vj\ max} = 175^{\circ}C$	$I_{C\ nom}$	450	A
总功率损耗 Total power dissipation	$T_C = 25^{\circ}C$ , $T_{vj\ max} = 175^{\circ}C$	$P_{tot}$	2250	W
集电极重复峰值电流 Repetitive peak collector current	$t_p = 1\ ms$	$I_{CRM}$	900	A
栅极-发射极电压 Gate emitter voltage		$V_{GE}$	$\pm 20$	V

### 特征值 / Characteristic Values

Parameter	Conditions	Symbol	Value			Unit
			Min.	Typ.	Max.	
集电极-发射极饱和电压 Collector-Emitter saturation voltage	$V_{GE} = 15V$ , $I_C = 450A$ $T_{vj} = 25^{\circ}C$ $V_{GE} = 15V$ , $I_C = 450A$ $T_{vj} = 125^{\circ}C$ $V_{GE} = 15V$ , $I_C = 450A$ $T_{vj} = 150^{\circ}C$	$V_{CE\ sat}$		2.10 2.50 2.60	2.60	V
栅极-发射极阈值电压 Gate-Emitter threshold voltage	$I_C = 17mA$ , $V_{GE} = V_{CE}$ , $T_{vj} = 25^{\circ}C$	$V_{GEth}$	5.10	5.70	6.30	
栅电荷 Gate charge	$V_{GE} = -15V \dots +15V$	$Q_G$		2.19		$\mu C$
内部栅极电阻		$R_{Gint}$		1.60		$\Omega$

Internal gate resistor						
输入电容 Input capacitance	$f=1\text{MHz}, V_{CE}=25\text{V}, V_{GE}=0\text{V}$	$T_{vj}=25^\circ\text{C}$	$C_{ies}$	34.80	nF	
反向传输电容 Reverse transfer capacitance			$C_{res}$	1.30		
集电极-发射极截止电流 Collector-emitter cut-off current	$V_{CE}=1200\text{V}, V_{GE}=0\text{V}$	$T_{vj}=25^\circ\text{C}$	$I_{CES}$	2	mA	
栅极-发射极漏电流 Gate-emitter leakage current	$V_{CE}=0\text{V}, V_{GE}=20\text{V}$	$T_{vj}=25^\circ\text{C}$	$I_{GES}$	200	nA	
开通延迟时间 Turn-on delay time	$I_C=450\text{A}, V_{CE}=600\text{V}$ $V_{GE}=\pm 15\text{V}, R_G=1.8\Omega$ (电感负载) / (inductive load)	$T_{vj}=25^\circ\text{C}$	$t_{don}$	177		
		$T_{vj}=125^\circ\text{C}$		199		
		$T_{vj}=150^\circ\text{C}$		198		
上升时间 Rise time	$I_C=450\text{A}, V_{CE}=600\text{V}$ $V_{GE}=\pm 15\text{V}, R_G=1.8\Omega$ (电感负载) / (inductive load)	$T_{vj}=25^\circ\text{C}$	$t_r$	66		
		$T_{vj}=125^\circ\text{C}$		65		
		$T_{vj}=150^\circ\text{C}$		66		
关断延迟时间 Turn-off delay time	$I_C=450\text{A}, V_{CE}=600\text{V}$ $V_{GE}=\pm 15\text{V}, R_G=1.8\Omega$ (电感负载) / (inductive load)	$T_{vj}=25^\circ\text{C}$	$t_{doff}$	312	ns	
		$T_{vj}=125^\circ\text{C}$		349		
		$T_{vj}=150^\circ\text{C}$		351		
下降时间 Fall time	$I_C=450\text{A}, V_{CE}=600\text{V}$ $V_{GE}=\pm 15\text{V}, R_G=1.8\Omega$ (电感负载) / (inductive load)	$T_{vj}=25^\circ\text{C}$	$t_f$	167		
		$T_{vj}=125^\circ\text{C}$		198		
		$T_{vj}=150^\circ\text{C}$		209		
开通损耗能量 (每脉冲) Turn-on energy loss per pulse	$I_C=450\text{A}, V_{CE}=600\text{V}$ $V_{GE}=\pm 15\text{V}, R_G=1.8\Omega$ (电感负载) / (inductive load)	$T_{vj}=25^\circ\text{C}$	$E_{on}$	11.17	mJ	
		$T_{vj}=125^\circ\text{C}$		14.20		
		$T_{vj}=150^\circ\text{C}$		16.67		
关断损耗能量 (每脉冲) Turn-off energy loss per pulse	$I_C=450\text{A}, V_{CE}=600\text{V}$ $V_{GE}=\pm 15\text{V}, R_G=1.8\Omega$ (电感负载) / (inductive load)	$T_{vj}=25^\circ\text{C}$	$E_{off}$	39.35	mJ	
		$T_{vj}=125^\circ\text{C}$		48.51		
		$T_{vj}=150^\circ\text{C}$		51.47		
短路数据 SC data	$V_{GE}\leq 15\text{V}, V_{CC}=800\text{V}$ $V_{CEmax}=V_{CES}-L_{sCE}\cdot di/dt$	$t_p\leq 10\mu\text{s}, T_{vj}=150^\circ\text{C}$	$I_{SC}$	1525	A	
结-外壳热阻 Thermal resistance, junction to case	每个 IGBT/per IGBT		$R_{thJC}$	0.066	K/W	
在开关状态下温度 Temperature under switching conditions			$T_{vj op}$	-40	150	$^\circ\text{C}$

## 二极管, 逆变器 / Diode, Inverter

### 最大额定值 / Maximum Ratings

Parameter	Conditions	Symbol	Value	Unit
反向重复峰值电压 Repetitive peak reverse voltage	$T_{vj}=25^\circ\text{C}$	$V_{RRM}$	1200	V
连续正向直流电流 Continuous DC forward current		$I_F$	450	A
正向重复峰值电流 Repetitive peak forward current	$t_p=1\text{ms}$	$I_{FRM}$	900	A
$I^2t$ 值 $I^2t$ -value	$t_p=10\text{ms}, \sin 180^\circ, T_j=125^\circ\text{C}$	$I^2t$	12100	$\text{A}^2\text{s}$

## 特征值 / Characteristic Values

Parameter	Conditions	Symbol	Value			Unit
			Min.	Typ.	Max.	
正向电压 Forward voltage	$I_F=450A, V_{GE}=0V$ $I_F=450A, V_{GE}=0V$ $I_F=450A, V_{GE}=0V$	$T_{vj}=25^{\circ}C$ $T_{vj}=125^{\circ}C$ $T_{vj}=150^{\circ}C$	$V_F$	2.40 2.60 2.50	2.90	V
反向恢复峰值电流 Peak reverse recovery current	$I_F=450A, -di_F/dt=6650A/\mu s$ $V_R=600V$ $V_{GE}=-15V$	$T_{vj}=25^{\circ}C$ $T_{vj}=125^{\circ}C$ $T_{vj}=150^{\circ}C$	$I_{RM}$	262 344 349		A
恢复电荷 Recovered charge	$I_F=450A, -di_F/dt=665A/\mu s$ $V_R=600V$ $V_{GE}=-15V$	$T_{vj}=25^{\circ}C$ $T_{vj}=125^{\circ}C$ $T_{vj}=150^{\circ}C$	$Q_f$	18.90 41.20 41.50		$\mu C$
反向恢复损耗（每脉冲） Reverse recovered energy	$I_F=450A, -di_F/dt=6650A/\mu s$ $V_R=600V$ $V_{GE}=-15V$	$T_{vj}=25^{\circ}C$ $T_{vj}=125^{\circ}C$ $T_{vj}=150^{\circ}C$	$E_{rec}$	9.93 21.76 21.85		mJ
结-外壳热阻 Thermal resistance, junction to case	每个二极管 / per diode		$R_{thJC}$		0.10	K/W
在开关状态下温度 Temperature under switching conditions			$T_{vj op}$	-40	150	$^{\circ}C$

## 负温度系数热敏电阻 / NTC-Thermistor

### 特征值 / Characteristic Values

Parameter	Conditions	Symbol	Value			Unit
			Min.	Typ.	Max.	
额定电阻值 Rated resistances	$T_c=25^{\circ}C, \pm 5\%$	$R_{25}$		5.0		K $\Omega$
B-值 B-value	$\pm 2\%$	$B_{25/50}$		3375		K

## 模块 / Module

Parameter	Conditions	Symbol	Value			Unit
绝缘测试电压 Isolation test voltage	RMS, f=50Hz, t=1min	$V_{ISOL}$	2500			V
内部绝缘 Internal isolation			Al <sub>2</sub> O <sub>3</sub>			
储存温度 Storage temperature		$T_{stg}$	-40		125	$^{\circ}C$
模块安装的扭矩 Mounting torque for modul mounting		M	3.0		6.0	Nm
重量 Weight		W		342		g



图 1. 典型输出特性 ( $V_{GE}=15V$ )

Figure 1. Typical output characteristics ( $V_{GE}=15V$ )

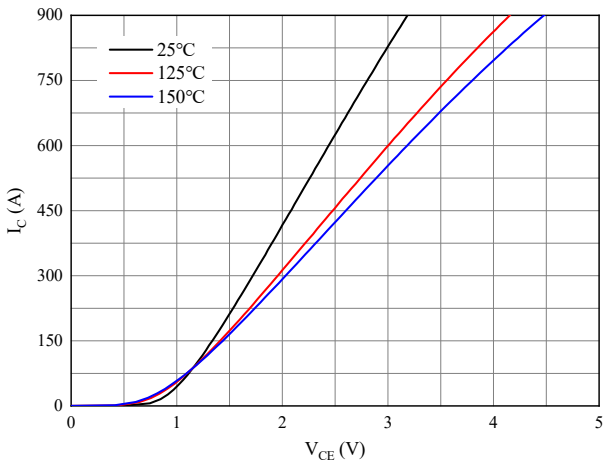

图 2. 典型输出特性 ( $T_{vj}=150^{\circ}C$ )

Figure 2. Typical output characteristics ( $T_{vj}=150^{\circ}C$ )

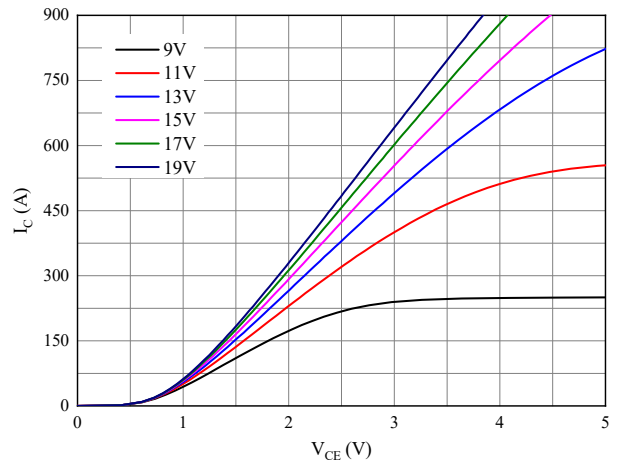

图 3. 典型传输特性 ( $V_{CE}=20V$ )

Figure 3. Typical transfer characteristic ( $V_{CE}=20V$ )

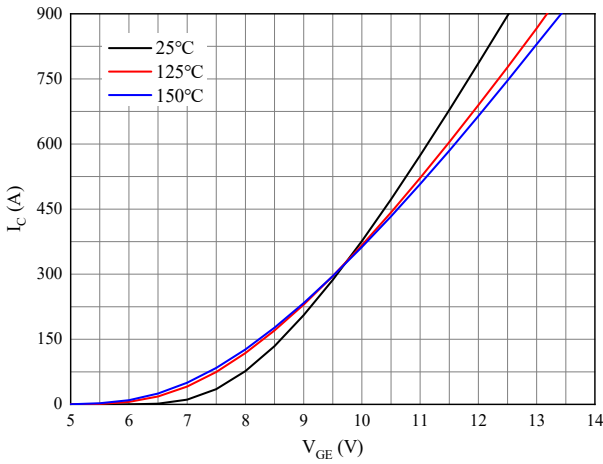

图 4. 正向偏压特性 二极管

Figure 4. Forward characteristic of Diode

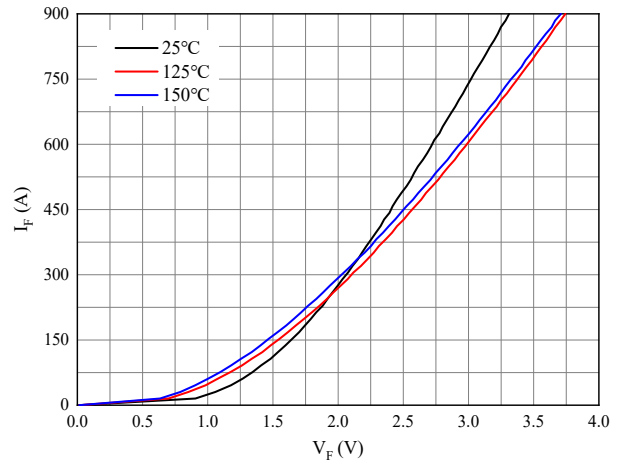

图 5. 开关损耗 逆变器

Figure 5. Switching losses of IGBT

$V_{GE}=\pm 15V$ ,  $R_{Gon}=1.8\Omega$ ,  $R_{Goff}=1.8\Omega$ ,  $V_{CE}=600V$

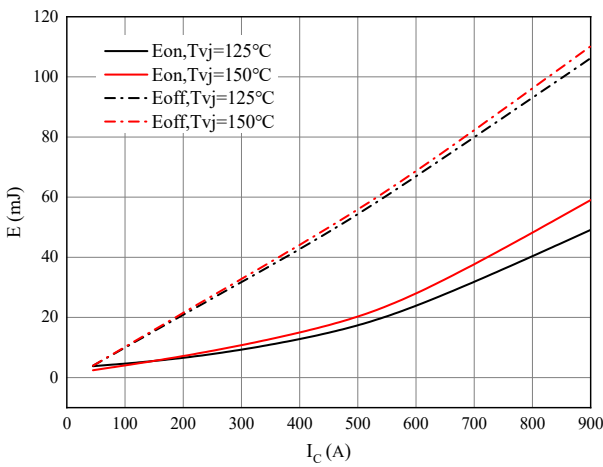

图 6. 开关损耗 逆变器

Figure 6. Switching losses of IGBT

$V_{GE}=\pm 15V$ ,  $I_C=450A$ ,  $V_{CE}=600V$

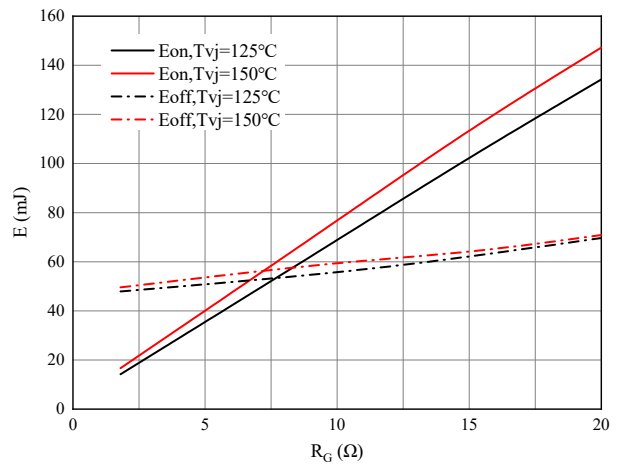

图 7. 开关损耗 二极管

Figure 7. Switching losses of Diode  
R<sub>Gon</sub>=1.8Ω, V<sub>CE</sub>=600V

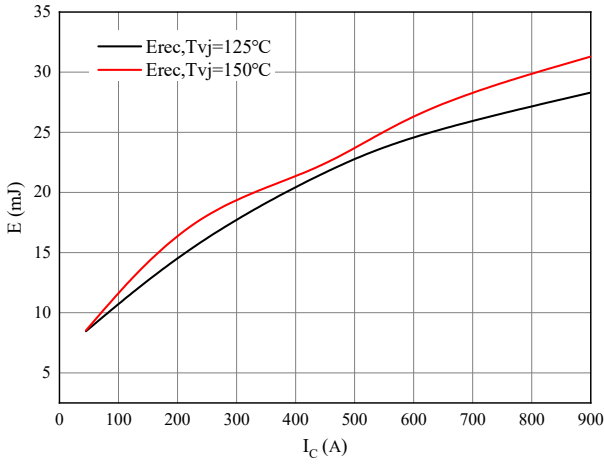

图 8. 开关损耗 二极管

Figure 8. Switching losses of Diode  
I<sub>F</sub>=450A, V<sub>CE</sub>=600V

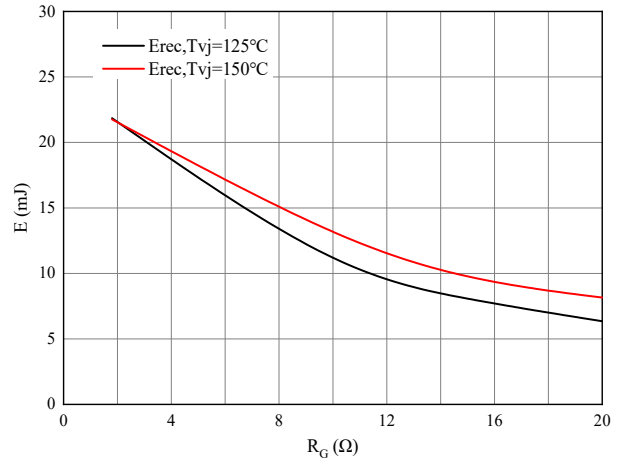

图 9. 电容特性

Figure 9. Capacitance characteristic

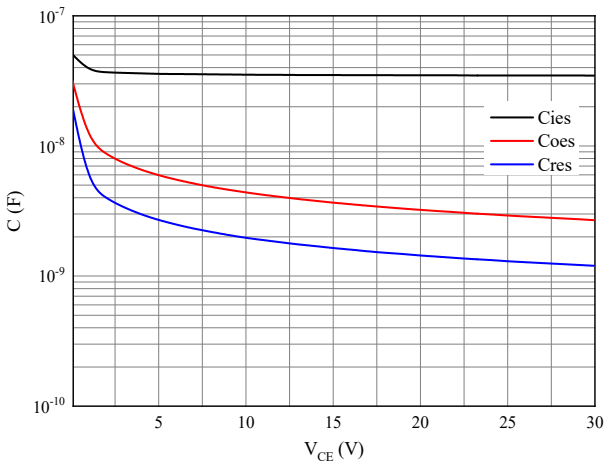

图 10. 负温系数热敏电阻 温度特性

Figure 10. NTC-Thermistor-temperature characteristic

接线图 / Circuit diagram

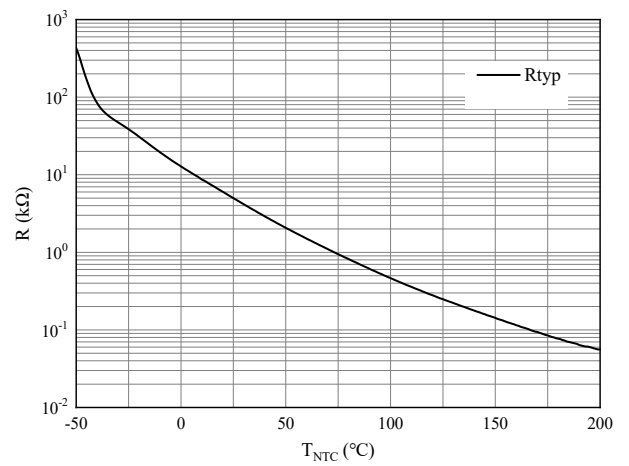
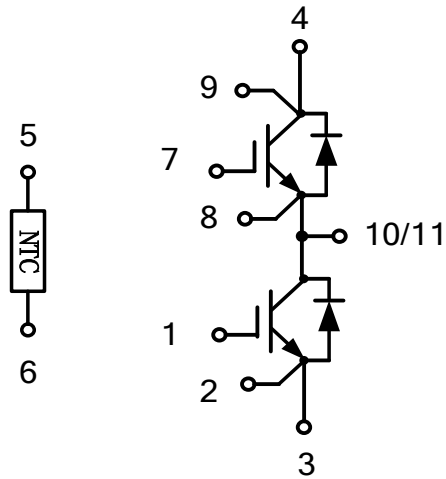

封装尺寸 / Package outlines

